

MIN-FDPH SERIES

18GA RECESSED FLANGE WITH DROP HINGE DOOR

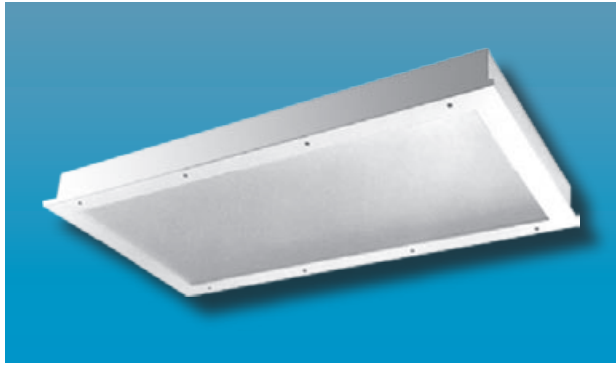

MEDIUM SECURITY

Specifier's Reference

Project Name	Type
Catalog No.	
Comments	

- **Listings/Certifications:** ETL(US/Canada).

Specifications

- **Housing:** 18-gauge cold rolled steel housing with lapped and welded seams.
- **Door:** 18-gauge cold rolled steel drop hinged door with mitered corners and closed cell gasket.
- **Lens:** .375" thick clear polycarbonate standard. Optional lensing shown below.
- **Gasket:** 4lb density polyester foam standard. Closed cell available with -WL Wet Location option.
- **Lamps:** See below for lamping options. Lamps supplied by others.
- **Lens Retention:** Full length, vertically adjustable "Z" shaped retaining angles secured by through studs and die cast locknuts.
- **Ballasts:** Standard universal voltage 120V through 277V electronic 90% power factor <10% THD. Other ballast options available.
- **Finish:** Standard baked white polyester powder coat paint finish. Optional AgION™ antimicrobial finish available.
- **Mounting:** Standard mounting hardware, 14-Ga galvanized steel "U" channel mount, accommodates various ceiling types & thicknesses. Optional plaster frame also available.

Ordering Information

Example: **MIN - FDPH - 24 - F - 4 - T5 - EB10IS - 7/A - SSD - F1 - UNV**

Series	Size	No. Lamps	Lamp Type	Ballast Type	Lens Type	Fasteners	Options	Voltage
MIN-FDPH	<input type="text"/>	<input type="text"/>	<input type="text"/>	<input type="text"/>	<input type="text"/>	<input type="text"/>	<input type="text"/>	<input type="text"/>
	-24 2 X 4 Unit	-4 Four Lamps (2X4 or 2X2 only)	-T8 32W (2X4) 17W (2X2) 32W (1X4)	-EB10IS Electronic Ballast <10% THD Instant Start	ENVIRONMENT -3 .250" Clear Polycarbonate (standard)	-F1 Allen Head - center pin reject, standard	-EMG1 1-Lamp Emergency Power Pak 500 Lumen initial output, 90 minute, 32° start temp.	-UNV (120V- 277V) -347V
	-22 2 X 2 Unit	-3 Three Lamps	-T5 28W (2X4) 14W (2X2) 28W (1X4)	-SB Specified Ballast	-7 .250" Clear Tempered Glass LAMP SIDE	-SF Specified Fastener	-EMG2 2-Lamp Emergency Power Pak 1100 Lumen initial output, 90 minute, 32° start temp.	
	-14 1 X 4 Unit	-2 Two Lamps	-T5HO 54W (2X4) 24W (2X2) 54W (1X4)		-A .125 Prismatic Acrylic -C .140 DR Prismatic Acrylic -G .156 Prismatic Tempered Glass -UV .007 UV Absorbing Overlay		-SSD Stainless Steel Door, CRS Housing -SS Stainless Steel Door & Housing -AG AgION™ Antimicrobial Protec- tion in Powder Coat Paint -PF Plaster Frame -GLR GLR/HLR Fuse & Holder set -PL7 7W PL Nightlight -WL Wet Location	

Note: Contact Factory For Additional Configurations.

Morlite
TOUGH SITES TOUGH LITES

1805 Pittsburgh Ave, Erie, PA 16502 • 800-865-5954 • Fax 800-667-9959



MIN-FDPH SERIES
 MINIMUM SECURITY RECESSED FLANGE
 WITH DROP HINGE DOOR



Dimensions & Mounting

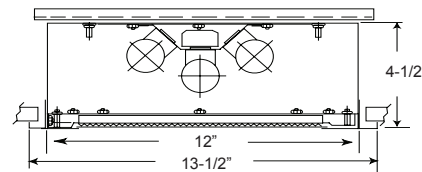
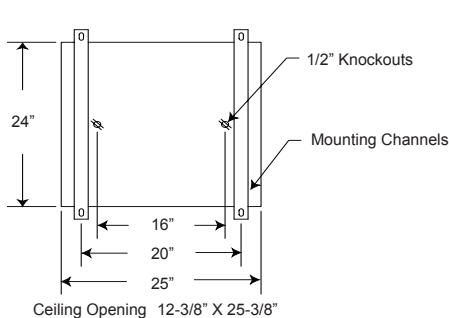
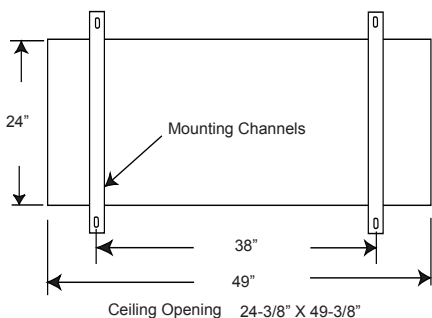
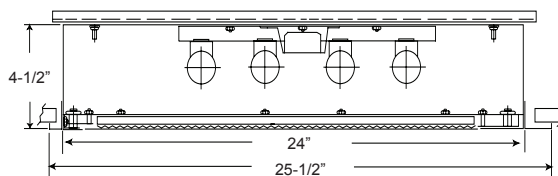
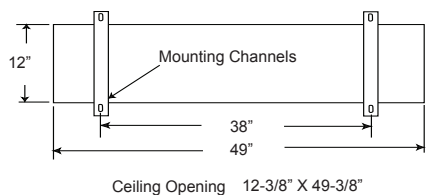

Photometry

Zonal Cavity Coefficient of Utilization
 I.T.L. Test No. ITL 37545, Product Catalog Number:
 MIN-FDPH-24-F-4-T8-EB10IS-4/A-SSD-F1-UNV
 Lamps: Four 32WT8, each rated 3150

Floor Ceilings Walls(%)	80%				70%				50%			
	70	50	30	10	70	50	30	10	70	50	30	10
0	67	67	67	67	66	66	66	66	63	63	63	63
1	63	61	59	57	61	59	57	56	57	55	54	54
2	58	54	51	48	57	53	50	48	51	49	47	47
3	54	49	45	42	53	48	44	41	46	43	41	41
4	50	44	40	36	49	43	39	36	42	38	36	36
5	46	39	35	31	45	43	34	31	38	34	31	31
6	42	36	31	28	41	35	31	28	34	30	27	27
7	39	32	27	24	38	32	27	24	31	27	24	24
8	36	29	24	21	35	28	24	21	28	24	21	21
9	33	26	21	18	32	26	21	18	25	21	18	18
10	31	24	19	16	30	23	19	16	23	19	16	16

**Candlepower
Distribution**

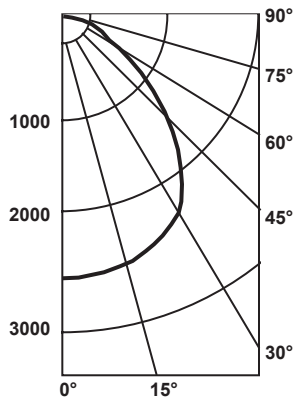

**Average Luminance
in Footlamberts**

Vertical Angles	Average Brightness	
	Norm	Para
45°	1369	1174
55°	1085	924
65°	664	646
75°	490	475
85°	309	309

Lumin. Effi.	Spacing Cross	Maint. Factor
56.6%	1.3	85%

Options

Antimicrobial: Agion™ Antimicrobial protection using silver technology inhibits bacterial colonization on metal interior and exterior surfaces. Agion™ antimicrobial FDA recognized and EPA registered, meeting all applicable EPA standards.



.125 Prismatic Acrylic
Lens Standard